

**SPECIFICATION DRAWING**

TUB MK 17

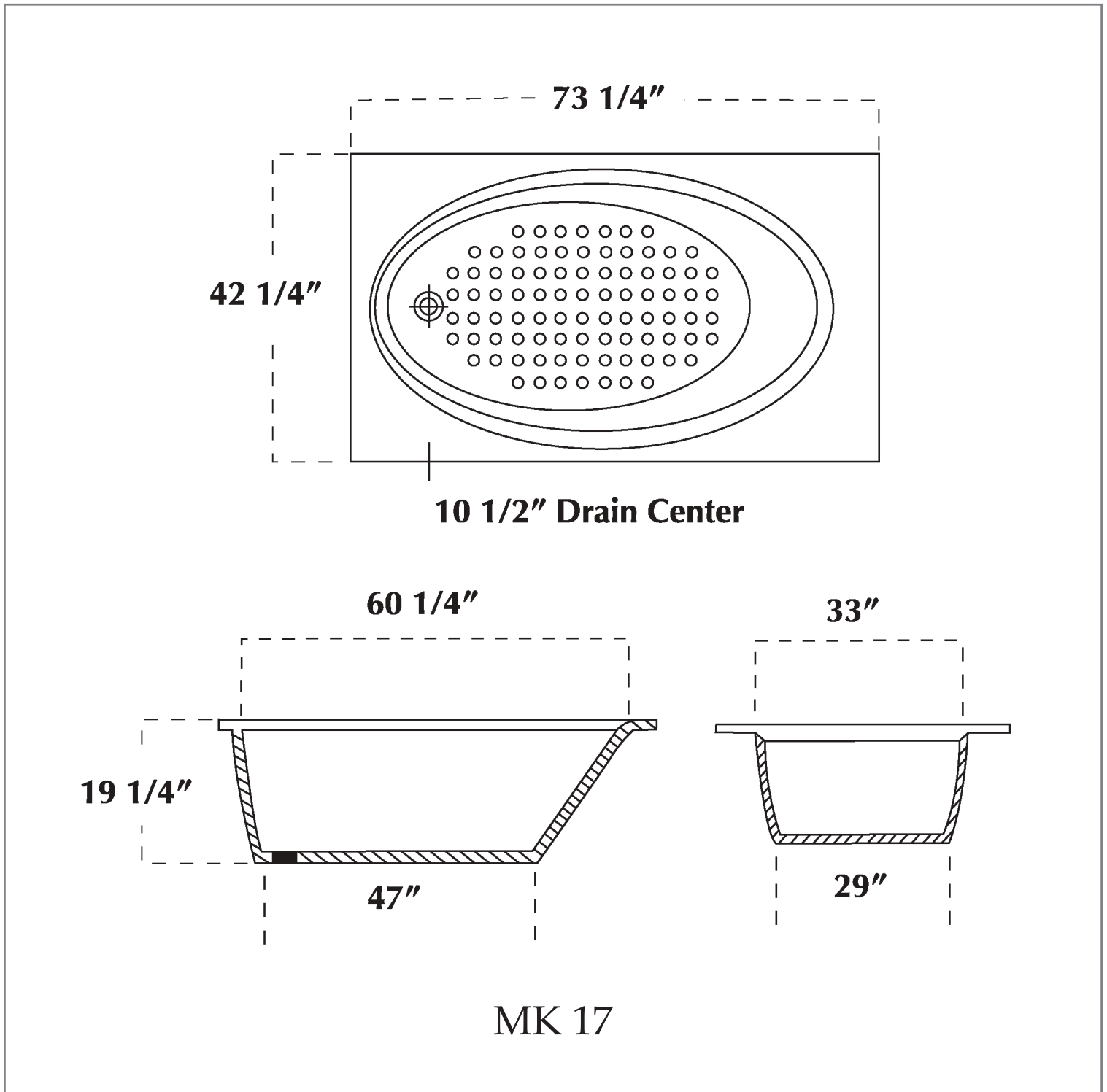

MK 17