

SPECIFICATION DRAWING

LOW PROFILE WALK-IN SHOWER PAN

Threshold height: 1-1/2" / Threshold width 2-1/4"
Tile flange (3 wall sides): 1/2" tall x 1/4" thick / Overall height including flange: 2"
Drain Diameter: 3-1/2"

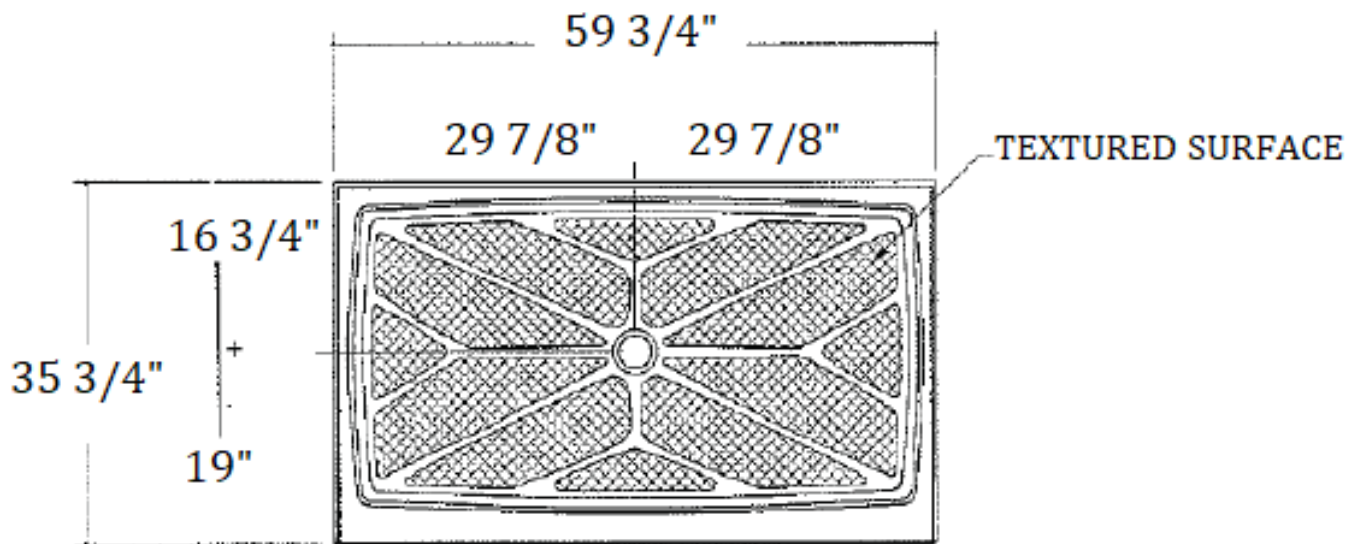

WALK-IN 60" X 36"
60" FRONT
1053-10